



ABBOTTS OFFICE FURNITURE

170 BURWOOD ROAD
HAWTHORN

PH. 03 9818 8866
Fax. 03 9818 8114

sales@abbottsfurniture.com.au

www.abbottsfurniture.com.au

WORKSTATIONS - FURNITURE - SEATING - STORAGE - ACCESSORIES

ABBOTTS OFFICE FURNITURE

SINCE 1978

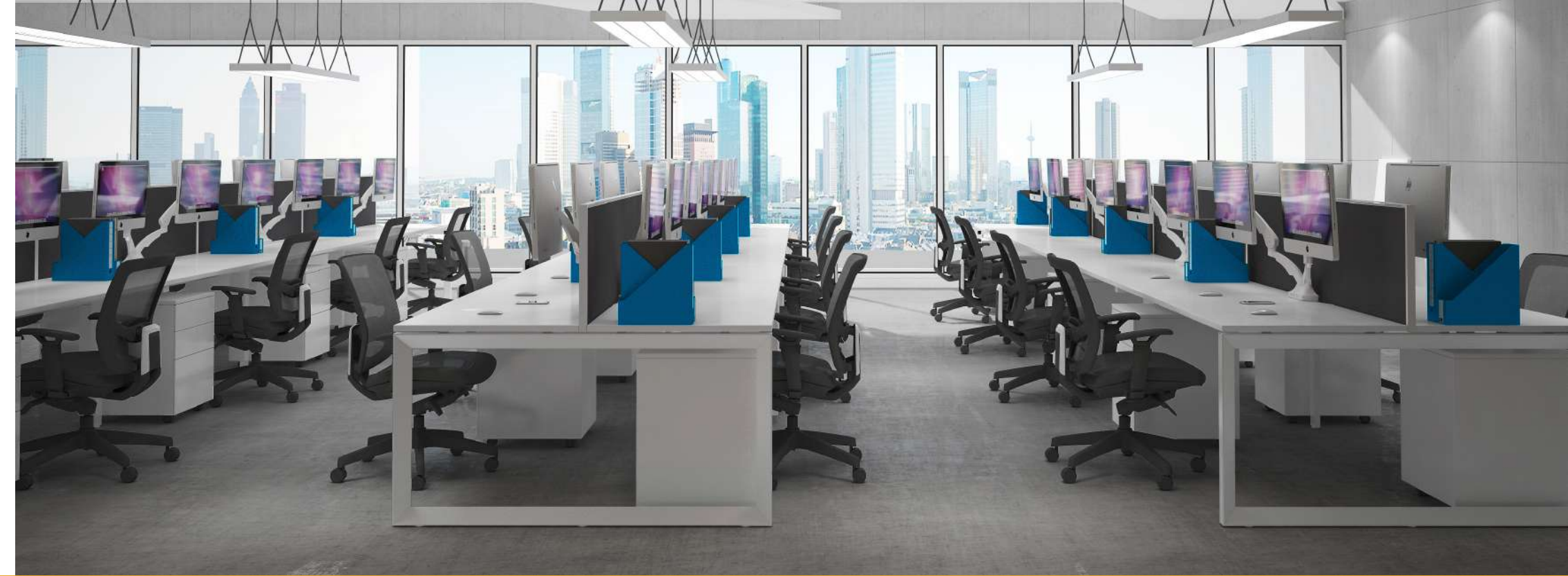

The catalogue aims to provide a comprehensive furniture range from which you can completely furnish your office - from home office to multiple workstation fit outs.

All products are selected from Sedex compliant factories around the globe and supported by full commercial warranties. Our product development team strives to establish and maintain high quality standards and selects recognised certified bodies such as AFRDI, BIFMA and GREENGUARD with as many products as possible.

The product is only part of the story - Rapidline product is supported by:
Privately-owned and managed distribution centres across Sydney, Melbourne, Brisbane and Perth
Full delivery and installation service
National customer service teams
In house marketing and projects team
Design and layout service

CONTENTS

PAGES

4 - 6	RAPID INFINITY
7	RAPID WIRING
8 - 11	RECEPTION & LOUNGE
12 - 15	RAPID SCREEN
16 - 19	RAPID SPAN WHITE
20 - 23	RAPID SPAN BEECH
24 - 26	TABLES
27 - 30	HEIGHT ADJUSTABLE WORKSTATIONS
31	MONITOR ARMS
32 - 33	RAPID VIBE
34 - 35	RAPID WORKER
36 - 37	RAPID MANAGER
38 - 40	MESH CHAIRS
41 - 43	OPERATOR CHAIRS
44 - 45	VISITOR CHAIRS
46 - 47	EXECUTIVE CHAIRS
48	CONFERENCE & EVENTS
49	HOSPITALITY
50	OTTOMANS
51	ACCESSORIES
52 - 56	STEEL STORAGE

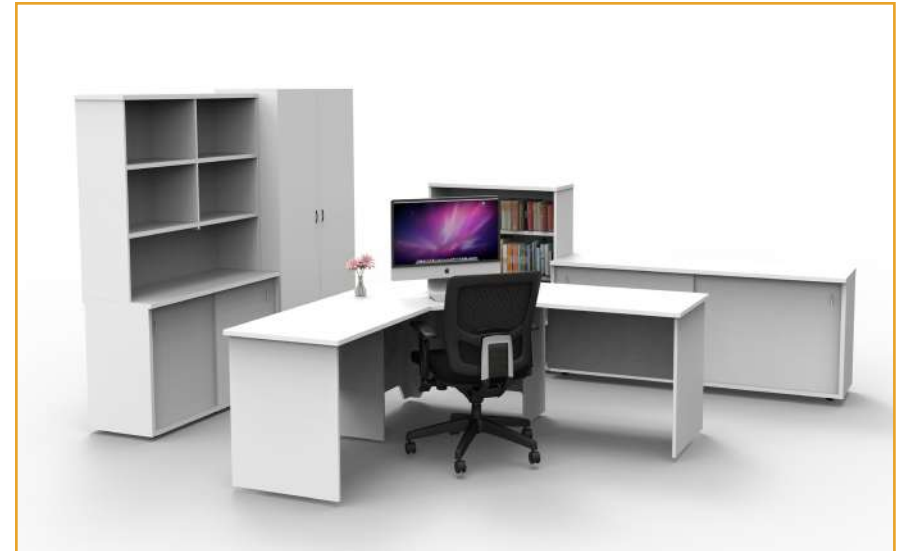

RAPID INFINITY

The Rapid Infinity Bench Workstation System



Select the Loop End Leg for a Distinctive, Premium Finish.

Pinable Black Screen provides Privacy whilst also Reducing Noise.

ASK FOR A QUOTE & FLOOR PLAN

Profile 60 x 30mm End Leg Creates Simple, Clean Lines.



Double Telescopic Rail for Rigid Support.

Recessed Intermediate Leg for Maximum Leg Space.

Choose from the Profile or Loop Leg.





Rapid Infinity

Maximise floor space and leg room with the stylish Rapid Infinity bench workstation system. Choose between two different end leg styles and include screens to create clean, space efficient workstation runs suitable for single, up to large numbers of users.

WORKSTATION TOP SIZES

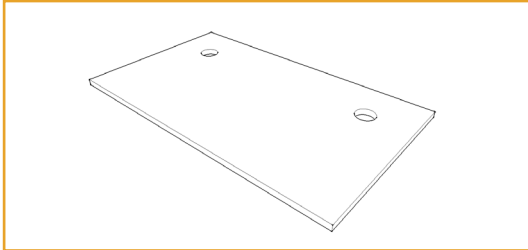

1200mm W x 700mm D x 25mm

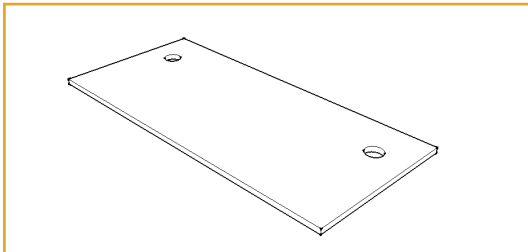

1500mm W x 700mm D x 25mm

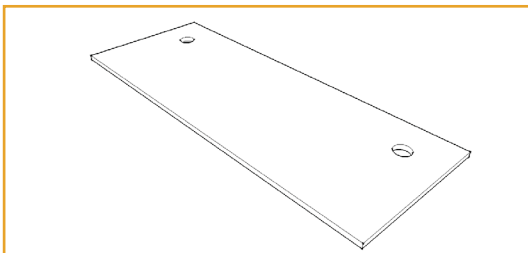

1800mm W x 700mm D x 25mm

TOP COLOURS



Warm White



Beech

SCALLOP TOP



Scallop Top without Cable Entry Holes
1200mm W x 700mm D x 25mm
1500mm W x 700mm D x 25mm
1800mm W x 700mm D x 25mm



Brilliant White ONLY

SCREENS



IS700 B
T Return Screen
690mm W x 20mm T x
350mm H - Screw Fix

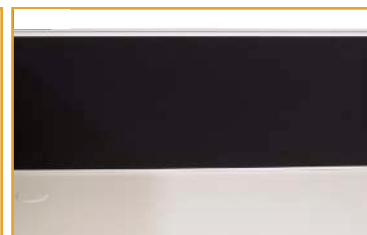

IS1200 B, IS1500 B, IS1800 B
Pinnable Black Screen
Top W x 30mm T x 500mm H
Black with White Frame

SCREEN COLOURS



Black





▪ Single Sided, No Screens



▪ Single Sided with Screens



▪ Double Sided with Screens

E1 ENVIRO BOARD

WORKSTATION LEG SYSTEMS

Profile Leg - 60mm + 30mm



PSL W Single Profile Leg
700mm W x 60mm D x 695mm H

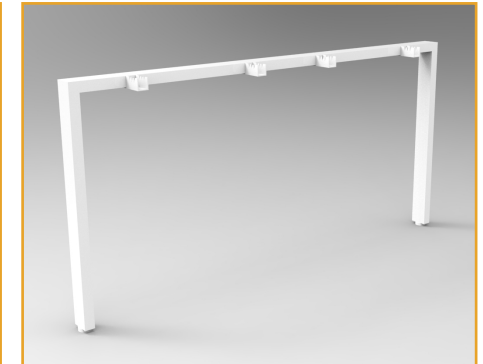

PDL W Double Profile Leg
1430mm W x 60mm D x 695mm H

Loop Leg - 60mm + 45mm



LSL W Single Loop Leg
700mm W x 45mm D x 695mm H

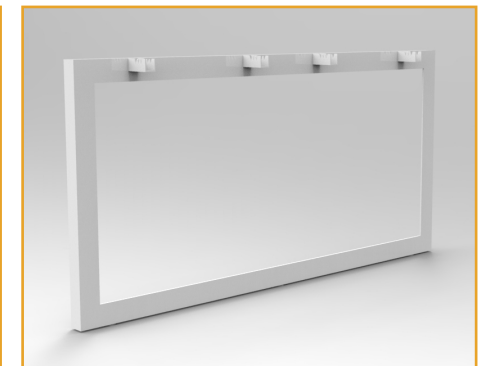

LDL W Double Loop Leg
1430mm W x 45mm D x 695mm H



White Powdercoated Steel ONLY

Cable Management Solutions

- Bringing power to the workstation.

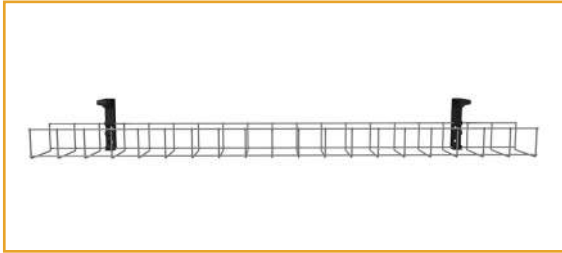

Single Tier Cable Basket

- Under workstation cable tidy.



Dual Tier Cable Baskets Kits

- Under desk, for power and data provisions.



Power Rails

- Above desk power and data, clamps onto desk top.



Flip Box

- In desk power and data, suits cut out size 220mm x 80mm. Choose from power only, power and data, or power and USB.



In Desk Module - Use for Hot Desks

- Above desk power, data and double USB, fits in 80mm cable port.



Pop Up Power - Use for Hot Desks

- Above desk power or power and USB. Suits cut out size 200mm x 100mm. Great for single workstations, hot desks and boardrooms.



Power Pole Kits

- Run power and data from ceiling to workstation, or from ceiling to floor. Anodised finish, umbilicals also available.



Boardroom Table Boxes

- Sits in table top, lid closes to obscure power and data points. Suits cut out 295mm x 148mm. Bead blasted natural finish.

RECEPTION AND LOUNGE



Reception and Lounge

The reception area is the bridge between your clients and management. Make the best possible first impression with a fresh, professional looking counter whilst allowing your visitors to wait in comfort with a range of fantastic soft seating designs.

E1 ENVIRO BOARD



WHITE 2000 COUNTER WITH RETURN



Brilliant White ONLY
W2RCW 2200W X 780D X 1045H
W2RW Return 1000W x 600D x 730H

\$999

\$325



Brilliant White

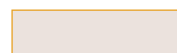

Warm White

WHITE 2000 COUNTER



Brilliant White ONLY
Glass Top Reception Unit
W2RCW 2200W x 780D x 1045H

\$199



Brilliant White

MODULAR COUNTER



Modular Reception Counter with 2 Mix & Match Units
Warm White ONLY
MOD1W Full Height Module 1339W x 872D x 1160H
MOD2W Glass Top Module 1339W x 872D x 935H

\$553

\$625

RC1809



NEW

Brilliant White with Black
Powdercoat Cowl and Kickplate
RC1809 BW 1800W x 800D Workspace

\$749



Brilliant White

BEECH COUNTER WITH RETURN



E1 ENVIRO BOARD

FINISHES
Beech



Available in Beech ONLY
RWRC18 1800W x 762D x 1067H
RWRCR11 Return 1066W x 610D x 1040H

\$408

\$198

BEECH COUNTER



Available in Beech ONLY
RWRC15 1500W x 762D x 1067H
RWRC18 1800W x 762D x 1067H

\$357

\$408

FLOW COUNTER



Available in Beech ONLY
Curved Reception Counter with Glass Feature
NCT1160 2400 x 1600 x 800D

\$1069



RECEPTION AND LOUNGE



Reception and Lounge Chairs

Mix and Match the Splash Range in different fabric colours to brighten up any contemporary office space.

Chair Dimension Codes
SW = Seat Width
SD = Seat Depth
BH = Back Height
GH = Gas Height Range



SPACE TUB 1



\$261

SW	540mm	Compact Tub Chair for Small Spaces in PU Finish
SD	430mm	
BH	370mm	

SPACE EXECUTIVE



\$349

SW	480mm	Large Tub Chair with Flared Armrest Feature
SD	470mm	
BH	390mm	

SPLASH CLUB



\$429

SW	480mm	Tub Style with Gas Height Adjustment
SD	520mm	
GH	460-590mm	

SPLASH CUBE



\$429

SW	460mm	Contemporary Style with Chrome Sled Base
SD	520mm	
BH	330mm	

SPLASH CONE



\$429

SW	500mm	Circular Seat with Chrome Cross Base
SD	510mm	
BH	390mm	

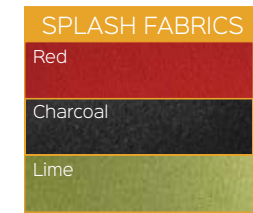

SPACE 1



\$419

SW	550mm	Soft Black PU Finish, Stylish Frame
SD	515mm	
BH	310mm	

SPACE 2



\$619

SW	1110mm	Ideal for Reception or Meeting Areas
SD	515mm	
BH	310mm	

SPACE 3



\$819

SW	1670mm	PU Upholstery for Easy Maintenance
SD	515mm	
BH	310mm	

RECEPTION AND LOUNGE

\$540

ENTERPRISE 1



SW 530mm Comfortable
SD 510mm Blue Fabric
BH 320mm Upholstery

\$735

ENTERPRISE 2



SW 1010mm Mid Blue Finish
SD 510mm Adds Colour to
BH 320mm Any Space

\$940

ENTERPRISE 3



SW 1530mm Generous Size
SD 510mm with Chrome
BH 320mm Sled Base

Chair Dimension Codes

SW = Seat Width

SD = Seat Depth

BH = Back Height

GH = Gas Height Range



\$499

VENUS 1



SW 630mm Classic Design,
SD 500mm Distinctive
BH 400mm Button Finish

\$699

VENUS 2



SW 1120mm Pair with
SD 500mm Matching
BH 400mm Ottoman

\$919

VENUS 3



SW 1770mm Ideal for
SD 500mm Reception or
BH 400mm Meeting Areas

\$240

VENUS OTTOMAN



SW 1030mm Use as an
SD 540mm Ottoman or
H 410mm Foot Stool

E1 ENVIRO BOARD

RAPID 50



Rapid 50 Coffee Table
White 50mm Frame
R50CT 1200W x 600D x 450H **\$199**

BLACK GLASS



Black Glass Coffee Table
AGT66 600W x 600D x 450H **\$249**
AGT126 1200W x 600D x 450H **\$293**

E1 ENVIRO BOARD

BUDGET



Budget Coffee Table
Ironstone Base
CT96 900W x 600D x 450H **\$129**

E1 ENVIRO BOARD

CHROME BASE



Round 600mm DIA. Coffee
Table with Chrome Base
CCT6 600 DIA. x 425H **\$198**

RAPID SCREEN



CREATE YOUR WORKSTATION ENVIRONMENT

- We can help with consultation and planning to providing drawings or 3D rendered images of your design.



ASK FOR A QUOTE & FLOOR PLAN



Rapid Screen Workstation System

Off the shelf, slimline workstation system with multiple configuration options. Slimline screen system with blue or grey screens in 1250mm or 1650mm heights. Choose between blue or grey fabric screens with warm white or beech desk tops. Select from different leg styles and colours to match your office workspace.



SCREEN COLOURS
Grey
Blue

TOP FINISHES
Beech
Warm White

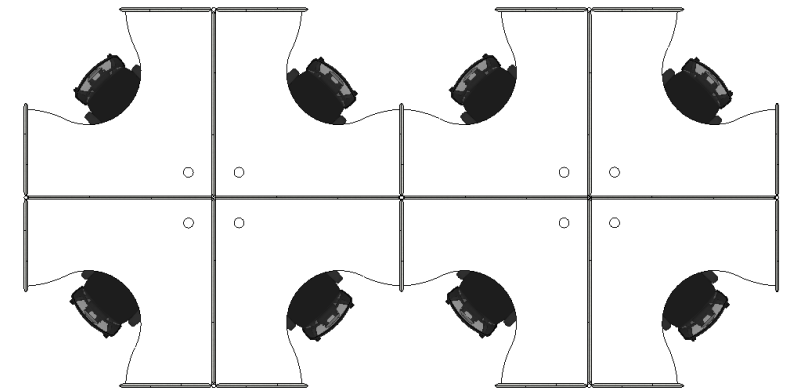
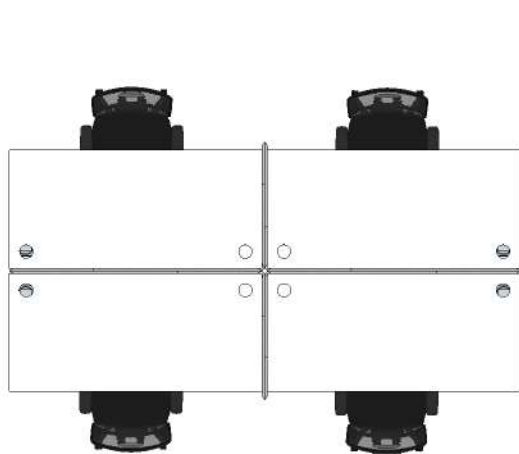

MAXIMISE SPACE WITH OPEN WORKSTATIONS

SPREAD OUT WITH A 3 WAY 120° WORKSTATION

4 WAY WORKSTATION FOR MAXIMUM DESK SPACE

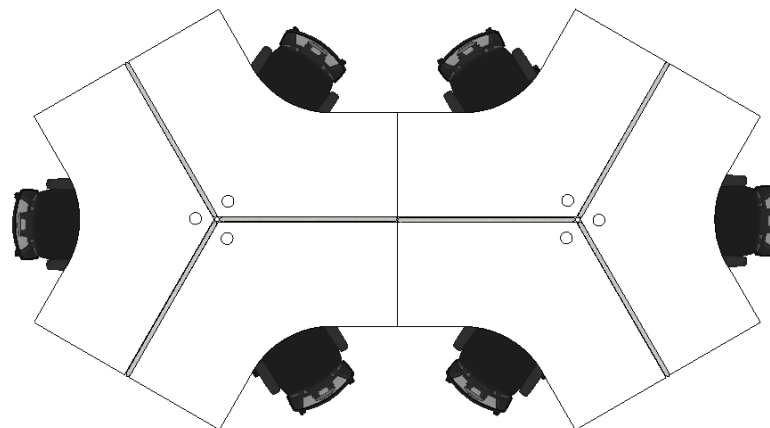

RAPID SCREEN

WORKSTATION TOP SIZES



WORKSTATION TOP COLOURS

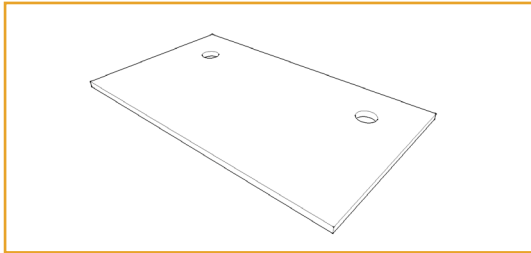

1200mm W x 700mm D x 25mm T

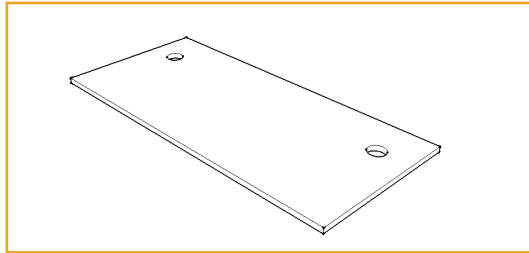

1500mm W x 700mm D x 25mm T

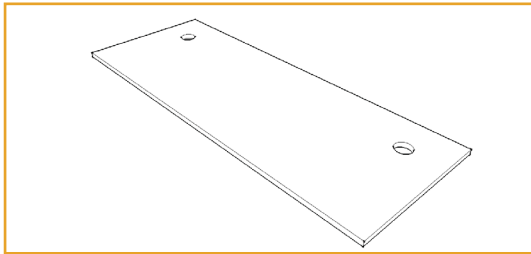

1800mm W x 700mm D x 25mm T

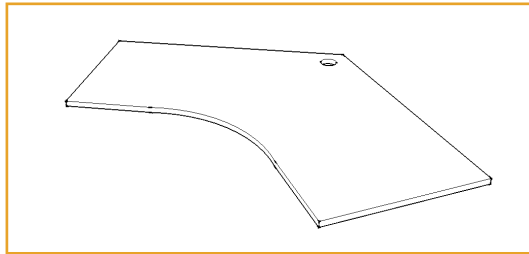

1200mm x 1200mm W x 700mm D x 25mm T

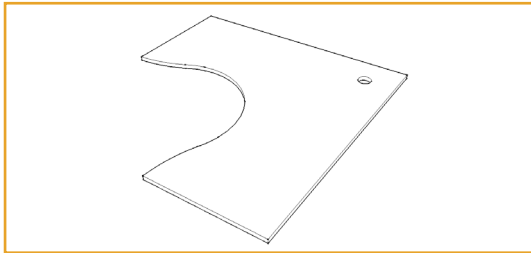

1500mm x 1500mm W x 700mm D x 25mm T

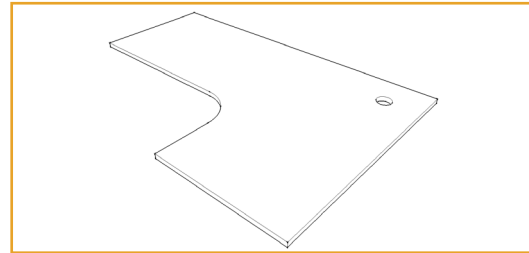

1800mm x 1200mm W x 700mm D x 25mm T

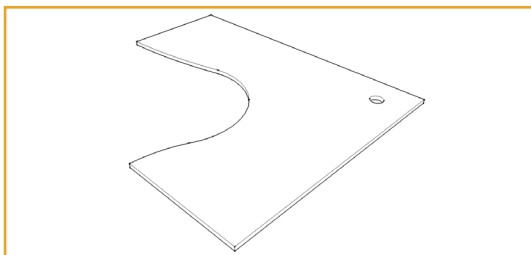

1800mm x 1500mm W x 700mm D x 25mm T

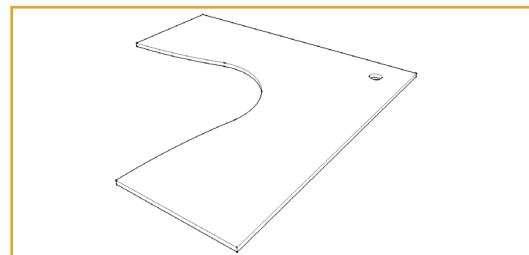

1800mm x 1800mm W x 700mm D x 25mm T

SCREEN HEIGHTS



1250mm HIGH SCREEN 1650mm HIGH SCREEN

750mm, 1200mm, 1500mm or 1800mm W
x 1250mm or 1650mm H x 30mm T

SCREEN COLOURS



WORKSTATION LEG SYSTEMS

SPAN LEGS

705mm H x 560mm D
Adjustable feet and cable tidy in leg



SPLEG
White



SPLEG
Black



SPLEG
Precious Silver

ADJUSTABLE LEG

650 - 800mm H
Tapered DIA. 65 to 50mm



AD LEG
White or Precious Silver

C LEG

705mm H x 550mm D
Adjustable feet

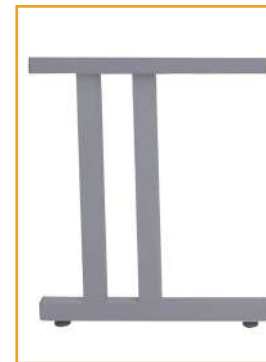

C LEG
Precious Silver

DC-60 POLE LEGS

60mm DIA. x 705mm H Round
Leg with Adjustable Foot



DC-60 LEG
Chrome, Black or White

NEW

SCREEN ACCESSORIES



900mm Shelf
Shown with Brackets



4 Space Document Divider



Document Tray



File Holder



JOINING POLES

1250mm or 1650mm High
Link screens at 90, 180 or
120 degrees. Use in corners
or to join return screens.



Double Pen Holder



Triple Pen Holder



Free Standing Foot



Wall Starter



RAPID SPAN WHITE

WHITE & SILVER CLEG DESK



1200 x 700 **\$122** 1500 x 700 **\$199** 1800 x 700 **\$250**
 Desk & Return 1800 x 700 / 1100 x 600 **\$376**

- Perforated Metal or Melamine Modesty Panels
- Image above: White Top, White Melamine Modesty Panel and Silver C Legs.

WHITE & SILVER CORNER WORKSTATION



1500 x 1500 x 700 **\$386** 1800 x 1200 x 700 **\$371**
 1800 x 1500 x 700 **\$399** 1800 x 1800 x 700 **\$409**

- Perforated Metal or Melamine Modesty Panels
- Image above: White Top, Silver Metal Modesty Panel and Silver Span Legs.

WHITE & SILVER SPAN DESK WITH RETURN



Desk & Return 1800 x 700 / 1100 x 600 **\$386**

- Perforated Metal or Melamine Modesty Panels
- Image above: White Top with Return, Silver Melamine Modesty Panels and Silver Span Legs.

WHITE & WHITE SPAN DESK



1200 x 700 **\$222** 1500 x 700 **\$240** 1800 x 700 **\$261**
 Desk & Return 1800 x 700 / 1100 x 600 **\$386**

- Perforated Metal or Melamine Modesty Panels
- Image above: White Top, White Metal Modesty Panel and White Span Legs.

WHITE & BLACK CORNER WORKSTATION



1500 x 1500 x 700 **\$386** 1800 x 1200 x 700 **\$371**
 1800 x 1500 x 700 **\$399** 1800 x 1800 x 700 **\$409**

- Perforated Metal or Melamine Modesty Panels
- Image above: White Top, White Melamine Modesty Panel and Black Span Legs.

WHITE & WHITE SPAN DESK WITH RETURN



Desk & Return 1800 x 700 / 1100 x 600 **\$386**

- Perforated Metal or Melamine Modesty Panels
- Image above: White Top with Return, White Metal Modesty Panel and White Span Legs.

FRAME FINISHES

Silver
White
Black

WORKSTATION TOP SIZES



TOP FINISHES

Beech

Warm White

MODESTY FINISHES

White Perforated Metal

Black Perforated Metal

Silver Perforated Metal

Beech Melamine

Warm White Melamine

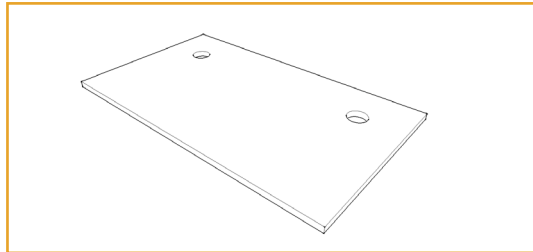

1200mm W x 700mm D x 25mm T

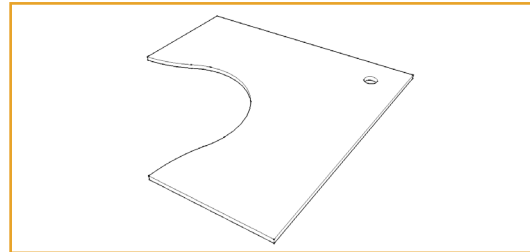

1500mm x 1500mm W x 700mm D x 25mm T

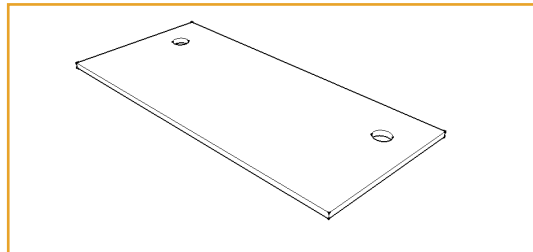

1500mm W x 700mm D x 25mm T

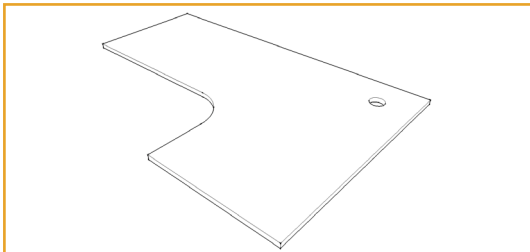

1800mm x 1200mm W x 700mm D x 25mm T

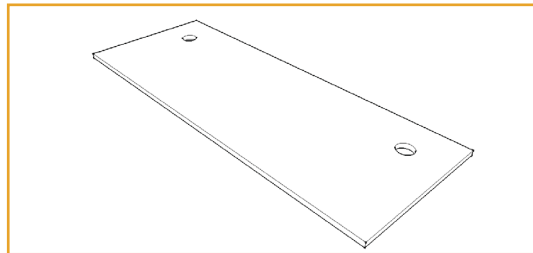

1800mm W x 700mm D x 25mm T

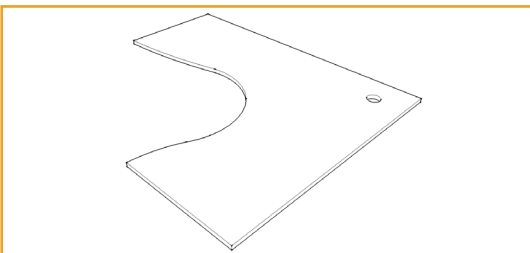

1800mm x 1500mm W x 700mm D x 25mm T

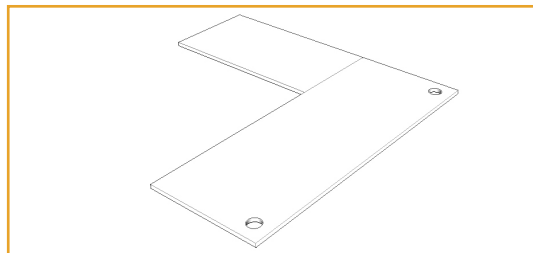

1800mm W x 700mm D / 1100mm W x 600mm D

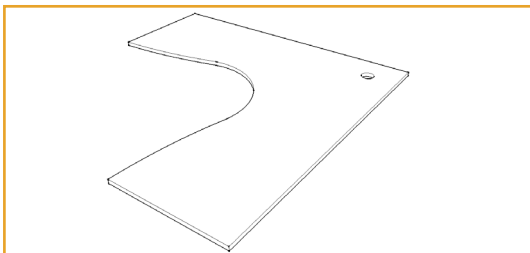

1800mm x 1800mm W x 700mm D x 25mm T



RAPID SPAN WHITE

Rapid Span Workstation System

Create a modern, clean office space with the Rapid Span white workstation and matching furniture range.



MODESTY PANEL STYLES



Metal Modesty Panel with Perforated Detail



Melamine Modesty Panel to match Desk Top

WORKSTATION LEG SYSTEMS

SPAN LEGS - SPLEG

705mm H x 560mm D

Adjustable feet and cable tidy in leg



C LEG

705mm H x
550mm D
Adjustable feet



WORKSTATION EXAMPLES



- Warm White Top, White Perforated Metal Modesty & White Span Legs



- Warm White Top, Black Perforated Metal Modesty & Black Span Legs

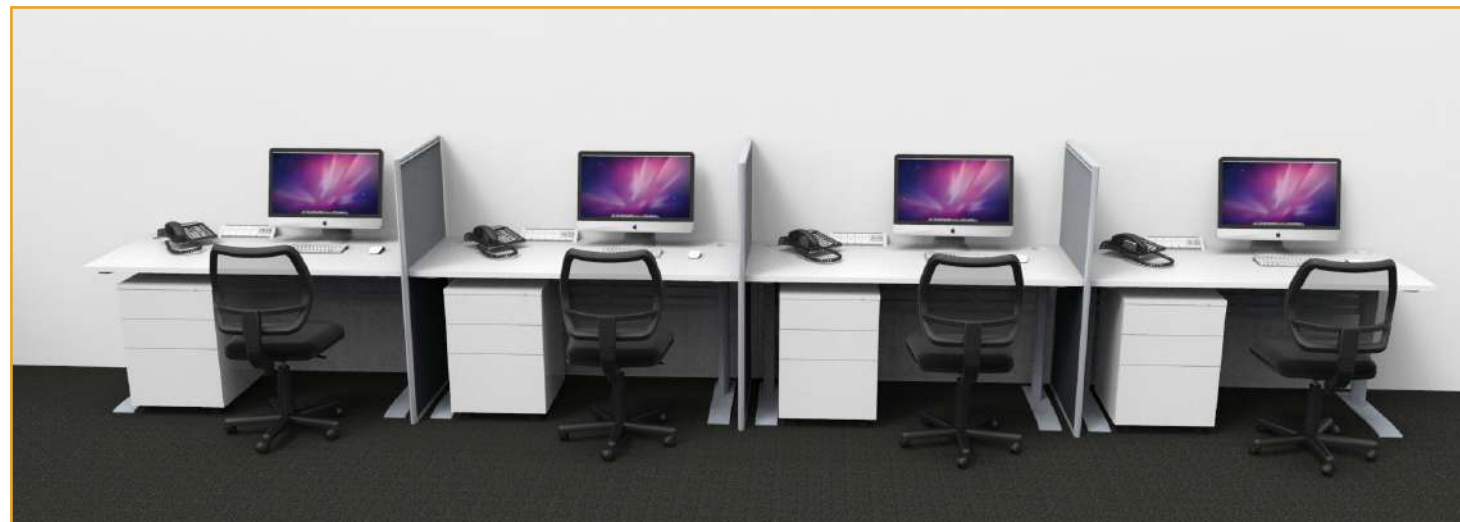

- Warm White Tops, Grey 1250H Screens, Perforated Metal Modesty and Span Legs in Silver



Rapid Span Furniture

Matching furniture and storage range to compliment any Rapid Span white desk or workstation.



CREDENZA



Includes 2 Adjustable Shelves

SPC12 1200W x 450D x 730H	\$314
SPC18 1800W x 450D x 730H	\$429

HUTCH



Includes Adjustable Shelves

SPH12 1200W x 315D x 1070H	\$230
SPH18 1800W x 315D x 1070H	\$299

SILVER FRAME MEETING



Rectangular Shaped Top with White Top and Silver Frame

RST189W 1800W x 900D x 730H	\$345
RST1875W 1800W x 750D x 730H	\$341

MOBILE PEDESTAL



447W x 465D x 690H
Lockable Mobile Pedestal
SPMP3 3 Drawers

\$199

CUPBOARD



Lockable, 1 Fixed, 3 Adjustable Shelves

SP2FD18 900W x 450D x 1800H	\$419
-----------------------------	-------

BOOKCASE



Includes Adjustable Shelves

SPBC12 900W x 315D x 1200H	\$209
SPBC18 900W x 315D x 1800H	\$287

TYPHOON BOARDROOM



FINISHES
Warm White

NEW

WARRANTY 5 YEARS

Typhoon Boardroom Table, Black and Chrome Frame

TTR189 1800 x 900 x 750H	Twin Post, Single Stage Frame	\$599
TTR2412 2400 x 1200 x 750H	Twin Post, Single Stage Frame	\$699
TTR3212 3200 x 1200 x 750H	Twin Post, Dual Stage Frame	\$950

4 STAR ROUND



4 Star Silver Round Base

RSRT6 600mm DIA. Top	\$217
RSRT9 900mm DIA. Top	\$240
RSRT12 1200mm DIA. Top	\$261

TYPHOON ROUND



NEW

Typhoon 4 Star Base Round Table
Black and Chrome Base with White Top

TTR900 900mm DIA. Top	\$250
TTR1200 1200mm DIA. Top	\$275

RAPID SPAN BEECH

BEECH & SILVER CLEG DESK



1200 x 700 **\$122** 1500 x 700 **\$199** 1800 x 700 **\$250**
 Desk & Return 1800 x 700 / 1100 x 600 **\$376**

- Perforated Metal or Melamine Modesty Panels
- Image above: Beech Top, Silver Metal Modesty Panel and Silver C Legs.

BEECH & WHITE CORNER WORKSTATION



1500 X 1500 X 700 **\$386** 1800 X 1200 X 700 **\$371**
 1800 X 1500 X 700 **\$399** 1800 X 1800 X 700 **\$409**

- Perforated Metal or Melamine Modesty Panels
- Image above: Beech Top, White Metal Modesty Panel and White Span Legs.

BEECH & SILVER SPAN DESK WITH RETURN

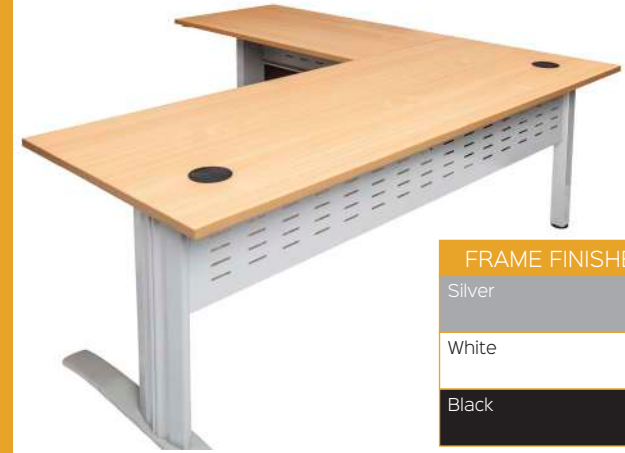

FRAME FINISHES	
Silver	
White	
Black	

Desk & Return 1800 x 700 / 1100 x 600 **\$386**

- Perforated Metal or Melamine Modesty Panels
- Image above: Beech with Return, Silver Metal Modesty Panels and Silver Span Legs.

BEECH & BLACK SPAN DESK



1200 x 700 **\$222** 1500 x 700 **\$240** 1800 x 700 **\$261**
 Desk & Return 1800 x 700 / 1100 x 600 **\$386**

- Perforated Metal or Melamine Modesty Panels
- Image above: Beech Top, Black Metal Modesty Panel and Black Span Legs.

BEECH & BLACK CORNER WORKSTATION



1500 X 1500 X 700 **\$386** 1800 X 1200 X 700 **\$371**
 1800 X 1500 X 700 **\$399** 1800 X 1800 X 700 **\$409**

- Perforated Metal or Melamine Modesty Panels
- Image above: Beech Top, Black Metal Modesty Panel and Black Span Legs.

BEECH & BLACK SPAN DESK WITH RETURN



Desk & Return 1800 x 700 / 1100 x 600 **\$386**

- Perforated Metal or Melamine Modesty Panels
- Image above: Beech Top with Return, Black Metal Modesty Panel and Black Span Legs.

WORKSTATION TOP SIZES

E1 ENVIRO BOARD

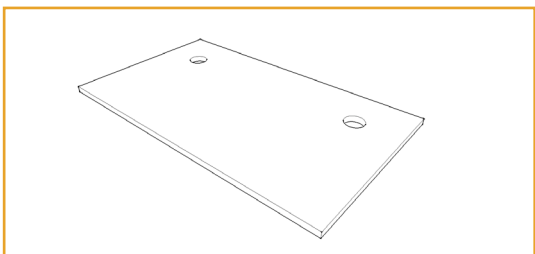

1200mm W x 700mm D x 25mm T

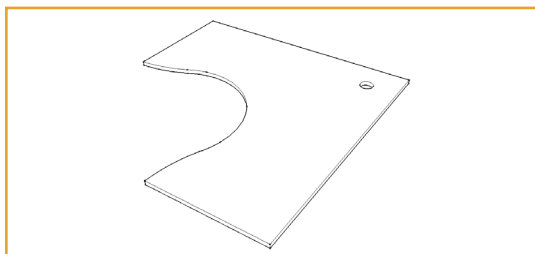

1500mm x 1500mm W x 700mm D x 25mm T

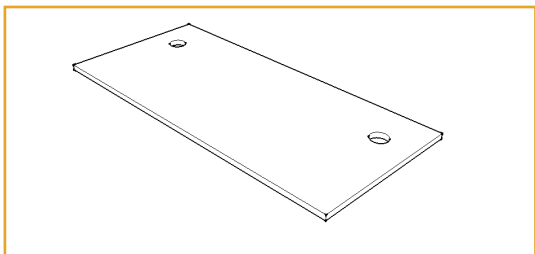

1500mm W x 700mm D x 25mm T

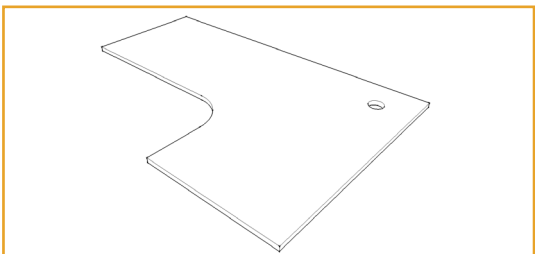

1800mm x 1200mm W x 700mm D x 25mm T

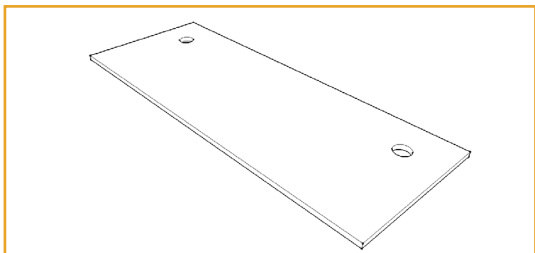

1800mm W x 700mm D x 25mm T

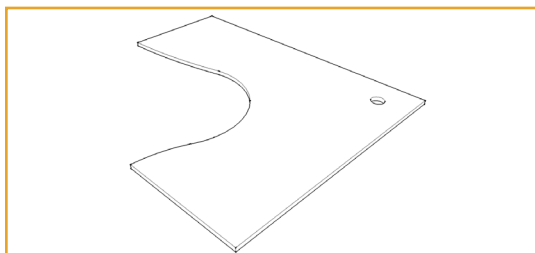

1800mm x 1500mm W x 700mm D x 25mm T

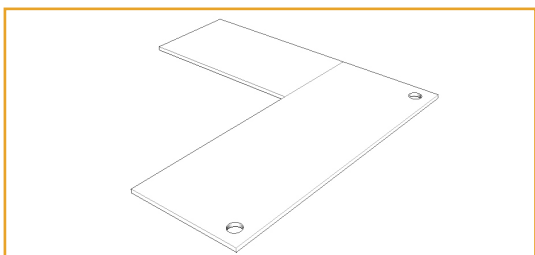

1800mm W x 700mm D / 1100mm W x 600mm D

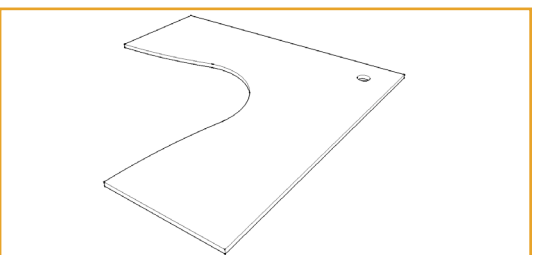

1800mm x 1800mm W x 700mm D x 25mm T

- ### TOP FINISHES
- Beech
 - Warm White

- ### MODESTY FINISHES
- White Perforated Metal
 - Black Perforated Metal
 - Silver Perforated Metal
 - Beech Melamine
 - Warm White Melamine



RAPID SPAN BEECH

Rapid Span Workstation System

Create a modern, clean office space with the Rapid Span beech workstation and matching furniture range.



MODESTY PANEL STYLES



Metal Modesty Panel with Perforated Detail



Melamine Modesty Panel to match Desk Top

WORKSTATION LEG SYSTEMS

SPAN LEGS - SPLEG

705mm H x 560mm D

Adjustable feet and cable tidy in leg



C LEG

705mm H x

550mm D

Adjustable feet

WORKSTATION EXAMPLES



▪ Beech Top, Silver Perforated Metal Modesty & Silver Span Legs



▪ Beech Top, Black Perforated Metal Modesty & Black Span Legs



▪ Beech Tops, Grey 1250H Screens, Perforated Metal Modesty and Span Legs in Silver



Rapid Span Furniture

Matching furniture and storage range to compliment any Rapid Span beech desk or workstation.



CREDENZA



Includes Adjustable Shelves
SPC12 1200W x 450D x 730H **\$314**
SPC18 1800W x 450D x 730H **\$429**

HUTCH



Includes Adjustable Shelves
SPH12 1200W x 315D x 1070H **\$230**
SPH18 1800W x 315D x 1070H **\$299**

SILVER FRAME MEETING



Rectangular Shaped Top with Silver Frame and Beech Top
RST189B 1800 x 900 x 730H **\$345**
RST1875B 1800 x 750 x 730H **\$341**

MOBILE PEDESTAL



447W x 465D x 690H
 Lockable Mobile Pedestal
SPMP3 3 Drawers **\$199**

CUPBOARD



Lockable, 1 Fixed, 3 Adjustable Shelves
SP2FD18 900W x 450D x 1800H **\$419**

BOOKCASE



Includes Adjustable Shelves
SPBC12 900W x 315D x 1200H **\$209**
SPBC18 900W x 315D x 1800H **\$287**

TYPHOON BOARDROOM



FINISHES
 Beech

NEW

WARRANTY 5 YEARS

Typhoon Boardroom Table, Black and Chrome Frame
TTR189 1800 x 900 x 750H Twin Post, Single Stage Frame **\$599**
TTR2412 2400 x 1200 x 750H Twin Post, Single Stage Frame **\$699**
TTR3212 3200 x 1200 x 750H Twin Post, Dual Stage Frame **\$950**

4 STAR ROUND



4 Star Silver Round Base
RSRT6 600mm DIA. Top **\$217**
RSRT9 900mm DIA. Top **\$240**
RSRT12 1200mm DIA. Top **\$261**

TYPHOON ROUND



NEW

Typhoon 4 Star Base Round Table
 Black and Chrome Base with Beech Top
TTR900 900mm DIA. Top **\$250**
TTR1200 1200mm DIA. Top **\$275**

TABLES



Tables

Huge range of tables including boardroom, lounge, breakout, meeting, coffee tables and educational applications.

STEEL FRAME TABLE



Steel Frame Table
40mm Black Legs with Adjustable Feet
1200W x 600D x 730H **\$209** 1500W x 750D x 730H **\$239**
1800W x 750D x 730H **\$259** 1800W x 900D x 730H **\$269**

FLIP TOP TABLE



Precious Silver Frame with Locking Castors
Use with Table Links to Connect Multiple
FTT1575 1500W x 750D x 730H **\$408**
FTT1875 1800W x 750D x 730H **\$419**

POLY FOLDING



Poly Folding Table
White Plastic Top and Silver Frame
PT1875 1800 x 750 x 730H **\$99**
PT209 2000 x 900 x 730H **\$130**

FOLDING TABLE



25mm Melamine Top with 30mm Black Frame
FFT1575 1500W x 750D x 730H **\$215**
FFT1875 1800W x 750D x 730H **\$240**
FFT189 1800W x 900D x 730H **\$254**

TYPHOON FLIP TOP



Typhoon Flip Top Table
Black and Chrome Finish
1500W x 750D x 730H **\$475**
1800W x 750D x 730H **\$510**

RAPID EDGE FOLDING



Rapid Edge Folding Boardroom Table, 18mm Thick Top,
Rubber Edging, Black and Chrome Frame, Locking Castors
Driftwood or White Top, Includes Pair of Table Links
FBT2410 2400 x 1000 x 743H **\$999**

TOP FINISHES
Beech
Warm White
Cherry
Grey

NEW

NEW

FINISHES
Driftwood
Brilliant White



CHROME BASE ROUND



Chrome Base Round Table
CBT6 600mm DIA. Top
CBT9 900mm DIA. Top
CBT12 1200mm DIA. Top

\$217
 \$240
 \$272

4 STAR ROUND



4 Star Silver Round Base
RSRT6 600mm DIA. Top
RSRT9 900mm DIA. Top
RSRT12 1200mm DIA. Top

\$217
 \$240
 \$261

2.4M BOARDROOM



Rectangular Shaped Top with Ironstone Base
 Available with White, Cherry or Grey Top
CBT2412 2400 x 1200 x 730H

\$366

NEW

IRONSTONE ROUND



Ironstone Base Round Table, Available with
 White, Cherry or Beech Top
CRM9 900mm DIA. Top
CRM12 1200mm DIA. Top

\$188
 \$198

TYPHOON 4 STAR



Typhoon 4 Star Base Round Table
 Black and Chrome Base
TTR900 900mm DIA. Top
TTR1200 1200mm DIA. Top

\$250
 \$275

NEW

3M BOARDROOM



Rectangular Shaped 2 Piece Top
 Available with Cherry or Beech Top
CBT3212 3200 x 1200 x 730H

\$589

NEW



TYPHOON BOARDROOM



NEW

Typhoon Boardroom Table, Black and Chrome Frame

TTR189 1800 x 900 x 730H Available with White, Beech, Cherry or Grey Top
TTR2412 2400 x 1200 x 730H Available with White, Beech, Cherry or Appletree Top
TTR3212 3200 x 1200 x 730H Available with White, Cherry or Beech Top

\$599
 \$699
 \$950

RAPID AIR BOARDROOM



NEW

Rapid Air Boardroom Table, Polished Aluminium Legs, Black Powdercoated Frame
RAB2412 2400 x 1200 x 730H Available with White, Beech, Cherry or Appletree Top
RAB3212 3200 x 1200 x 730H Available with White, Cherry or Beech Top

\$550
 \$680

TABLES



High Tables

High tables for drafting, perfect for hospitality or creating breakout areas.

HIGH BAR TABLE



NEW

High Bar Rectangular Table - 1050mm High
Black Powdercoated Frame, Adjustable Levelling Feet
HBT189 1800 x 900 x 1050H Available with White, Beech, Cherry or Grey Top

\$499

TOP FINISHES
Beech
Warm White
Cherry
Grey

DRY BAR



\$230

Dry Bar Round Table - 1070mm High
CDBT6 600mm DIA. Round Top x 1070H
Available with White, Beech or Cherry Top

DRAFTING TABLE



900mm High Drafting Table in all Top Colours

\$226

9SFT1575 1500 x 750 x 900H

9SFT189 1800 x 750 x 900H

\$257



HEIGHT ADJUSTABLE DESKS

Manual Height Adjustable Desk

Standalone manual height adjustable workstations, to adjust desk top height to suit user from sitting to standing position.

Low geared mechanism for ease of adjustment.

Universal crank handle, fold handle away when not in use.

FINISHES

Warm White

Rapid Surge Adjustable Desk

Standalone gas lift operated height adjustable desks, to adjust desk top height to suit user from sitting to standing position.

Improve posture, back pain and risk of weight gain by simply adjusting your work top height.

FINISHES

White

MANUAL HEIGHT ADJUSTABLE

NEW



Manually Height Adjustable Desk
Desk Height from 715mm to 1015 mm
Black Powdercoated Frame
Maximum Load 100kg
MHA

1200 W x 700 D
1500 W x 700 D
1800 W x 700 D

Available with White or Beech Top

\$599

\$659

\$699



RAPID SURGE HEIGHT ADJUSTABLE

NEW



Gas Lift Operated Height Adjustable Desk
Desk Height from 750mm to 1100mm
White Powdercoated Frame
Maximum Load 22kg
Control Levers Each Side
12 Different Height Settings
Worksurface Size:

1190 W x 590 D

Available with White Top and Frame

\$579



RAPID SPAN ELECTRIC

Rapid Span Electric Desks and Workstations

For many people a standard 730mm high desk height will not allow them to work comfortably and efficiently. When sharing workstations, a height adjustable workstation will be a valuable work tool to suit a range of users.

STRAIGHT DESK



PRODUCT CODES

SE 127 1200 W x 700 D \$749

SE 157 1500 W x 700 D \$849

SE 187 1800 W x 700 D \$899

SE 15157 1500 x 1500 x 700 D \$1250

SE 18127 1800 x 1200 x 700 D \$1228

SE 18157 1800 x 1500 x 700 D \$1333

SE 18187 1800 x 1200 x 700 D \$1352

- Desk height 685 - 1205mm
- Maximum load 100kg
- Modesty panel for rigidity
- Stiffening rail for tops
- 31mm per second speed

TOP FINISHES
Beech
Warm White

FRAME FINISHES
Silver
White

CORNER WORKSTATION



COMPONENTS



SS-SPLEG

Frame in White or Precious Silver
Modesty Panel Optional Extra



SS-SPCNR

Corner Pole



SS-PSC

Optional Pre Set Control
3 Height settings for up to 3 users



Paramount Height Adjustable Workstation System

The Paramount system exceeds expectations with stability, rigidity, strength and style.

The system provides full height adjustment from 630mm H to 1252mm H, and includes full cable management with an adaptable built in cable tray which also allows the option for power and data as an added extra.

SINGLE HEIGHT ADJUSTABLE



NEW

Single Height Adjustable Workstation
Desk Height from 630 to 1252 mm
White Frame and Top, Maximum Load 100 kg
REP1P187
1800 W x 750 D

SINGLE WITH SCREEN HEIGHT ADJUSTABLE



NEW

Single Height Adjustable Workstation with Screen
Desk Height from 630 to 1252 mm, Black Screen 500mm H
White Frame and Top, Maximum Load 100 kg
REPWS1P187
1800 W x 750 D

BACK TO BACK HEIGHT ADJUSTABLE



NEW

Back to Back Height Adjustable Workstation
Desk Height from 630 to 1252 mm
White Frame and Top, Black Screen 500mm H
Maximum Load 100 kg
REPWS2P187
1800 W x 750 D

E1 ENVIRO BOARD



RAPID RISER



Rapid Riser

Height adjustable solution for on top of existing desk or workstation. Generous size work surface, gas spring for smooth height adjustment and control levers each side. Built in iPad or phone holder and includes cable tie for any leads or cables. Grommet hole for monitor arm mounting.

RAPID RISER SMALL



Rapid Riser Small - White **\$359**
RR1 W 680 W x 590 D

RAPID RISER SMALL



Rapid Riser Small - Black **\$359**
RR1 B 680 W x 590 D

RAPID RISER MEDIUM



Rapid Riser Medium - White **\$449**
RR2 W 890 W x 590 D

RAPID RISER MEDIUM



Rapid Riser Medium - Black **\$449**
RR2 B 890 W x 590 D



Monitor Arms

Attaches to your existing or new desk and allows movement of monitor to best suit users height and eyeline.

- 5kg capacity per arm
- Fits 10-27" monitors
- Vesa holes 100 x 100 or 75 x 75
- Audio, microphone and USB 3.0 ports

SINGLE MONITOR ARM



Single Monitor Arm
SMARM 75-480mm Height Range **\$149**

DUAL MONITOR ARM



Dual Monitor Arm
DMARM 75-480mm Height Range **\$199**

REVOLVE SINGLE ARM



Revolve Pole Mounted Single Arm
RMA1 BL 260-360mm Height Range
392mm Overall Height, Cable Management within Pole **\$119**

REVOLVE DUAL ARM

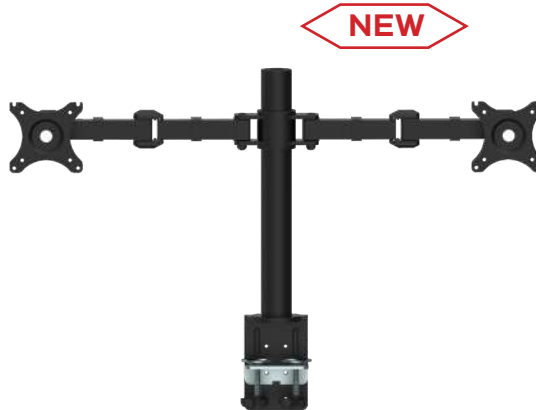

Revolve Pole Mounted Dual Arm
RMA2 BL 260-360mm Height Range
392mm Overall Height, Cable Management within Pole **\$159**

REVOLVE QUAD ARM



Revolve Pole Mounted Quad Arm
RMA4 BL 260-360mm Height Range
392mm Overall Height, Cable Management within Pole **\$219**

ELEVATE ARM



Elevate Arm
ELEVATE ARM 180-480mm Height Range
Also Available in Black, Gas Operated **\$170**





The Rapid Vibe Range

All White or Grey finishes for a clean, fresh look, 25mm thick tops on all desks and workstations. Locking storage and metal runners in all drawers.

E1 ENVIRO BOARD

FINISHES	
Warm White	
Grey	

DESK



CDK1575 1500W x 750D x 730H \$229
 CDK189 1800W x 900D x 730H \$239

CORNER WORKSTATION



CWS1818 1800 x 1800 x 600D \$331

DESK HOB



CHOB18N 1800W x 300D x 450H \$125

HOME OFFICE DESK



CDK126 1200W x 600D x 730H \$189
 HDKP1D Single Drawer Extra \$49

LAPTOP DESK



CDK96 900W x 600D x 730H \$167

MOBILE PEDESTAL



447W x 465D x 690H \$199
 Lockable Mobile Pedestal
 SPMP3 3 Drawers

FIXED PEDESTAL



Optional Extra for Desks \$120
 Lockable Fixed Pedestal
 CDKP3D 3 Drawers

DESK RETURN



Add to Straight Desks \$109
 CR6 900W x 600D



E1 ENVIRO BOARD

CREDENZA



Includes 2 Adjustable Shelves
 SPC12 1200W x 450D x 730H **\$314**
 SPC18 1800W x 450D x 730H **\$429**

HUTCH



Includes Adjustable Shelves
 SPH12 1200W x 315D x 1070H **\$230**
 SPH18 1800W x 315D x 1070H **\$299**

CUPBOARD



Lockable, 1 Fixed, 3 Adjustable Shelves
 SP2FD18 900W x 450D x 1800H **\$419**

BOOKCASE



Includes Adjustable Shelves
 SPBC12 900W x 315D x 1200H **\$209**
 SPBC18 900W x 315D x 1800H **\$287**



RAPID WORKER



The Rapid Worker Range

Sturdy, traditional, all melamine construction, 25mm thick tops on all desks and workstations. Locking storage and metal runners in all drawers.

E1 ENVIRO BOARD

FINISHES	
Beech	Ironstone
Cherry	Ironstone

DESK



CDK96	900W x 600D x 730H	\$109
CDK126	1200W x 600D x 730H	\$167
CDK1575	1500W x 750D x 730H	\$189
CDK1875	1800W x 750D x 730H	\$229
CDK189	1800W x 900D x 730H	\$239

* Drawers Not Included

CORNER WORKSTATION



1200 x 1200 x 600D	\$282	1200 x 1500 x 600D	\$303
1200 x 1800 x 600D	\$303	1200 x 2100 x 600D	\$345
1500 x 1500 x 600D	\$324	1800 x 1500 x 600D	\$329
1800 x 1800 x 600D	\$331	1800 x 1800 x 750D	\$394
2100 x 1500 x 600D	\$355	2100 x 1800 x 600D	\$357
2100 x 2100 x 600D	\$385		

* Drawers Not Included

DESK HOB



CHOB15N	1500W x 300D x 450H	\$121
CHOB18N	1800W x 300D x 450H	\$129

DESK RETURN



CR45	900W x 450D	\$109
CR6	900W x 600D	\$139
CR12	1200W x 600D	\$149

* Drawers Not Included

FIXED PEDESTAL



CDKP1D1F	2 Drawers	\$120
CDKP3D	3 Drawers	\$120
CRP3D	Return	\$115

MOBILE PEDESTAL



447W x 465D x 690H	
CMP2F 2 Drawers	\$219
CMP2D1F 2D, 1F	\$199
CMP4D 4 Drawers	\$219

MOBILE PEDESTAL



447W x 465D 690H	
Ironstone ONLY	\$189
Lockable Mobile Pedestal	
CMP2D1F-I 2 Drawers, 1 File	

CREDENZA



CMZ1245	1200W x 730D x 450H	\$299
CMZ1545	1500W x 730D x 450H	\$356
CMZ1845	1800W x 730D x 450H	\$434

DRAWER



Ironstone ONLY	
No Lock	
HDKP1D 1 Drawer	\$49



E1 ENVIRO BOARD

FINISHES	
Beech	Ironstone
Cherry	Ironstone

HUTCH



CH12	1200W x 315D x 1070H	Includes 4 Shelves	\$239
CH15	1500W x 315D x 1070H	Includes 4 Shelves	\$261
CH18	1800W x 315D x 1070H	Includes 6 Shelves	\$299

PIGEON HOLE UNIT



20 Hole Unit - Includes 16 Shelves		\$383
PH20	1040W x 380D x 1040H	

UTILITY TROLLEY



Ironstone ONLY		\$219
TR3	800W x 600D x 900H	

CUPBOARD



Lockable, includes 4 Shelves		\$399
CSC2FD	900W x 450D x 1800H	

LOCKABLE WALL UNIT



Lockable - Includes 4 Shelves		\$399
CSC2HD	900W x 450D x 1800H	

BOOKCASE



CBC9	900W x 315D x 900H	\$169
CBC12	900W x 315D x 1200H	\$219
CBC18	900W x 315D x 1800H	\$261

FILING CABINET



Lockable		\$375
C3FC	600W x 465D x 990H	
C4FC	600W x 465D x 1300H	\$419



RAPID MANAGER



The Rapid Manager Range

Classic dark wood style,
Melamine or metal base desk options.
Rounded corners on tops and full modesty panel.

E1 ENVIRO BOARD

FINISHES
Appletree
Ironstone

OPEN WORKSTATION



Appletree / Ironstone Desk
Optional Extra: VR6 Return 900W x 600D
Lockable Drawers Extra
VDK1575 1500W x 750D x 730H **\$229**
VDK1875 1800W x 750D x 730H **\$269**

CORNER WORKSTATION



Appletree / Ironstone Corner Workstation **\$399**
One Piece Top with Melamine Base
VCW186 1800 x 1800 x 600D x 730H

FIXED PEDESTAL



465W x 447D x 454H
Use with Ironstone Base
VDKP1D1F 1D, 1F **\$129**
VDKP3D 3 Drawers **\$129**

OPEN WORKSTATION



Appletree Top 750mm Deep
Metal Perforated Modesty Panel
Metal Span Legs
VDKMB1575 1500W x 750D x 730H **\$259**
VDKMB1875 1800W x 750D x 730H **\$289**

METAL BASE CORNER



Appletree One Piece Top 700mm Deep
One Piece Top with Black Metal Base
VCWMB186 1800 x 1800 x 600D x 730H **\$449**



FINISHES
 Appletree
 Ironstone

HUTCH



Appletree / Ironstone Hutch Storage
 Use with Melamine Base Desks
VH18 1800W x 380D x 1050H

\$366

RAPID AIR BOARDROOM



Rapid Air Boardroom Table
RAB2412 2400 x 1200 x 730H Available with Appletree Top
 Also available with Melamine Base

\$699

TYPHOON ROUND



Typhoon 4 Star Base Round Table
 Black and Chrome Base
 900mm DIA. Top
 1200mm DIA. Top

\$250

\$275

MOBILE PEDESTAL



\$240

447W x 465D 690H
 Lockable Mobile Pedestal
VMP2D1F 2 Drawers, 1 File

CUPBOARD



Lockable, includes 4 Shelves
VSC2FD 900W x 450D x 1800H

\$440

BOOKCASE



Appletree Shelves with Ironstone Sides
 Includes 4 Adjustable Shelves
VBC18 900W x 315D x 1800H

\$299

FILING CABINET



Lockable
 4 Drawers of Storage Space
V4FC 600W x 465D x 1300H

\$429

HOB



Reception Hob ONLY
 Add to Desk to create Reception Counter
VHOB18 Reception Hob

\$152

CREDENZA



Lockable Credenza
VCZ1245 1200W x 730D x 450H
VCZ1845 1800W x 730D x 450H

\$345

\$450



NEW PRO MESH CHAIRS

NEW MESH CHAIR SERIES

\$349



FABRICS

Black



SW 480mm
SD 545mm
GH 420-510mm

High Back Mesh Executive Chair with Synchro Mechanism, Adjustable Arms and Stylish White Frame

165KG WEIGHT RATING

\$349

FABRICS

Black



ERGO



SW 520mm
SD 490mm
GH 450-540mm

Fully Ergonomic with Seat Slide and Ratchet Back For Heavy Duty Use

\$209



FABRICS

Black



HARTLEY TASK



SW 500mm
SD 480mm
GH 440-520mm

Synchro Mech with Tension Control and Adjustable Arms

\$299

FABRICS

Black



KAL



SW 500mm
SD 510mm
GH 430-520mm

High Back with Lumbar Support, Synchro Mech and Adjustable Arms

\$199



FABRICS

Black



HARTLEY VISITOR



SW 510mm
SD 480mm
BH 485mm

Black Cantilever Frame Adjustable Arms Mesh Visitor Chair

Chair Dimension Codes

SW = Seat Width

SD = Seat Depth

BH = Back Height

GH = Gas Height Range

FABRICS

Black



\$199

ZOOM TABLET for use with Zoom Chair ONLY.

ZOOM



Tablet \$59



SW 460mm
SD 490mm
BH 330mm

Mesh Back, Foldable Training and Conference Chair, with Optional Extra Foldable Tablet Arm.

MESH CHAIRS

EM300

\$199

FABRICS
Black Fabric
Black PU



WARRANTY 5 YEARS

SW 490mm Fully Ergonomic, Black
SD 440mm Fabric or Black PU, Chrome
GH 460-590mm Base Optional Extra

AM300

\$408

FABRICS
Black



WARRANTY 5 YEARS

SW 525mm High Back, Infinite Lock
SD 510mm Tilt, Adjustable Arms and
GH 465-530mm Polished Aluminium Base

AM200

\$314

FABRICS
Black



WARRANTY 5 YEARS

SW 520mm Medium Back, Infinite Lock
SD 500mm Tilt, Adjustable Arms and
GH 420-520mm Polished Aluminium Base

AM100

\$229

FABRICS
Black



WARRANTY 5 YEARS

SW 470mm Fully Ergonomic with
SD 490mm Black Mesh Back
GH 460-550mm Arms as Standard

Mesh Chair Range

Mesh Chairs not only provide excellent ventilation and breathability keeping the user cool, comfortable and dry, minimise the risk of muscular fatigue throughout the working day but also provide a modern, fresher looking workspace.

Chair Dimension Codes

SW = Seat Width

SD = Seat Depth

BH = Back Height

GH = Gas Height Range

RIVER

\$293

FABRICS
Black



WARRANTY 10 YEARS

SW 480mm Synchro Back and Seat Tilt Adjustment,
SD 470mm Ratchet Back, Adjustable Arms
GH 460-570mm Available as Optional Extra

DAM

\$429

FABRICS
Black



WARRANTY 10 YEARS

SW 520mm AFRDI Level 6, Fully Ergonomic with
SD 470mm Tension Control, Heavy Duty Mesh,
GH 520-600mm Ratchet Back, Spider Base and Arms

AFRDI LEVEL 6

MESH CHAIRS

WMCC



WARRANTY 5 YEARS

FABRICS
Black

\$157

SW 470mm
SD 470mm
BH 500mm

Mesh Back with Fabric Seat, Cantilever Chrome Frame and Arms

WM600



\$299

FABRICS
Black Mesh

WARRANTY 5 YEARS

SW 510mm
SD 420mm
GH 480-590mm

Ideal Meeting Chair with Chrome Base and Arms, Comfortable Mesh Material

VIENNA



\$135

FABRICS
Black
Red
Lime
Blue
Silver

WARRANTY 3 YEARS

SW 490mm
SD 490mm
GH 430-550mm

Mesh Back Chair Suitable for Home Office or Light Commercial Use

WMVBK



\$167

FABRICS
Black

WARRANTY 5 YEARS

SW 480mm
SD 480mm
BH 480mm

Mesh Back Visitor or Meeting Chair with Arms and Chrome Legs

VESTA



FABRICS
Black

WARRANTY 1 YEAR

SW 460mm
SD 460mm
GH 430-530mm

Mesh Back Chair with Fabric Seat, Suitable for Home Office Use

RE100



\$180

FABRICS
Black

WARRANTY 1 YEAR

SW 510mm
SD 500mm
GH 470-590mm

Plastic Perforated Back, Single Point Lock, Arms, Home Office Use

PMVBK



\$139

FABRICS
Black

WARRANTY 5 YEARS

SW 455mm
SD 460mm
BH 300mm

Mesh Back, Plastic Seat with Sled Base, Linking and Stacking Chair

OPERATOR CHAIRS

Operator Chair Range

High quality range of operator chairs to suit a range of users.

Chair Dimension Codes

SW = Seat Width

SD = Seat Depth

BH = Back Height

GH = Gas Height Range

ET20

\$156

FABRICS
Black



WARRANTY 3 YEARS

SW 480mm Medium Back with Gas Lift,
SD 460mm Back and Seat Tilt,
GH 420-530mm Injection Moulded Foam

EC070CH

\$228

FABRICS
Black
Navy
Charcoal



WARRANTY 3 YEARS

SW 500mm High Back with Seat and
SD 450mm Back Tilt, Gas Lift and
GH 470-600mm Injection Moulded Foam

OPTIONAL EXTRAS



ADJUSTABLE ARMS

DRAFTING KIT

CHROME BASE

EC070BM

\$169

FABRICS
Black
Navy
Charcoal



WARRANTY 3 YEARS

AFRDI LEVEL 6

SW 500mm AFRDI Level 6,
SD 450mm Medium Back,
GH 470-600mm Back Tilt and Gas Lift

EC070BH

\$207

FABRICS
Black
Navy
Charcoal



WARRANTY 3 YEARS

SW 500mm High Back, Back Tilt,
SD 450mm Gas Lift and Injection
GH 470-600mm Moulded Foam Seat

EC070CM

\$184

FABRICS
Black
Navy
Charcoal



WARRANTY 3 YEARS

AFRDI LEVEL 6

SW 500mm AFRDI Tested Level 6, Fully
SD 450mm Ergonomic Medium Back Chair,
GH 470-600mm Seat and Back Tilt, Gas Lift

EC070BM DRAFTING CHAIR

\$216

FABRICS
Black



WARRANTY 3 YEARS

SW 500mm Drafting Chair with Medium Back,
SD 450mm Back Tilt, Gas Lift and Injection
GH 630-800mm Moulded Foam for Comfort

OPERATOR CHAIRS

Chair Dimension Codes

SW = Seat Width

SD = Seat Depth

BH = Back Height

GH = Gas Height Range

\$229

130KG WEIGHT RATING

FABRICS

Black

Red

OPTIONAL EXTRAS



ADJUSTABLE ARMS

DRAFTING KIT

CHROME BASE



LEVEL 6

ST50



SW 500mm
SD 470mm
GH 460-600mm

AFRDI Level 6, Fully Ergonomic Operator Chair with Tapered Back and Ratchet Back Adjustment, Available in Black or Red Fabric, Adjustable Arms Optional Extra

\$230

FABRICS

Black

Navy

Charcoal



LEVEL 6

EG100CH



SW 520mm
SD 480mm
GH 480-620mm

AFRDI Level 6, Fully Ergonomic with Back and Seat Tilt, Gas Lift, High Back, for User up to 130kg

\$299

FABRICS

Black

F300



SW 540mm
SD 450mm
GH 510-590mm

Fabric Operator Chair with Ratchet Back, Seat Slide, Chrome Base and Adjustable Arms

\$299

FABRICS

Black PU

PU300



SW 540mm
SD 450mm
GH 510-590mm

Fully Ergonomic Soft PU Chair with Ratchet Back, Seat Slide, Chrome Base and Arms

Operator Chair Range

High quality range of operator chairs and stools.

Chair Dimension Codes

SW = Seat Width

SD = Seat Depth

BH = Back Height

GH = Gas Height Range

OPTIONAL EXTRAS



ADJUSTABLE ARMS

DRAFTING KIT

CHROME BASE

EG400

\$240

FABRICS
 Black
 Navy
 Charcoal

AFRDI LEVEL 6



WARRANTY 10 YEARS

SW 520mm
 SD 480mm
 GH 480-620mm

AFRDI Level 6, Fully Ergonomic with Back and Seat Tilt, Gas Lift, Square Back, for User up to 130kg

PO500

\$314

FABRICS
 Black
 Navy
 Charcoal
 Black PU

AFRDI LEVEL 6



WARRANTY 10 YEARS

SW 530mm
 SD 510mm
 GH 490-590mm

AFRDI Tested Level 6, Fully Ergonomic High Back Chair, Seat and Back Tilt, Gas Lift

DS DESK

\$94

FABRICS
 Black PU



WARRANTY 3 YEARS

SW 400mm
 SD 400mm
 GH 450-570mm

400mm Round Seat Desk Stool, Easy to Clean Black PU Material

DS COUNTER STOOL

\$154

FABRICS
 Black PU



WARRANTY 3 YEARS

SW 400mm
 SD 400mm
 GH 650-870mm

400mm Round Seat Counter Stool, with Drafting Kit, Easy to Clean Black PU Material

VISITOR CHAIRS

HARTLEY VISITOR

\$199

NEW



FABRICS
Black



SW 510mm Mesh Back Visitor Chair with Comfortable Fabric Seat
SD 480mm Black Cantilever Frame
BH 485mm Adjustable Arms

CL2000V

\$399

FABRICS
Black Leather



SW 510mm Slimline Cantilever Visitor
SD 500mm Outward Adjust on Arms
BH 630mm Chrome Arms and Base

WMVBK

\$167

FABRICS
Black



SW 480mm Mesh Back, Fabric Seat
SD 480mm Visitor or Meeting Chair
BH 480mm Chrome Legs and Arms

WFV100 BL

\$113

FABRICS
Black

NEW



SW 440mm Comfortable Fabric Chair
SD 430mm Chrome Sled Base
BH 450mm Linking

NOVA

\$79

FABRICS
Black
Navy
Charcoal



SW 448mm Fabric Seat and Back
SD 444mm Black Frame
BH 338mm Linking and Stackable

WMCC

\$157

FABRICS
Black



SW 470mm Mesh Back, Fabric Seat
SD 470mm Stylish Cantilever Frame
BH 500mm Arms

Chair Dimension Codes

SW = Seat Width

SD = Seat Depth

BH = Back Height

GH = Gas Height Range

Chair Dimension Codes

SW = Seat Width

SD = Seat Depth

BH = Back Height

GH = Gas Height Range

\$83

FABRICS
Black PU



SW 425mm
SD 420mm
BH 480mm

Stylish Black PU
Chrome Frame
Stackable

COMFO

\$109

FABRICS
Black PU



SW 510mm
SD 490mm
BH 510mm

Visitor or Meeting Chair
Chrome Frame
Cantilever Base

V100

\$113

FABRICS
Black
Navy
Charcoal



SW 450mm
SD 450mm
BH 460mm

Comfortable Fabric
Visitor Chair
Stackable

VSB600

\$139

FABRICS
Black Fabric
Black PU



SW 490mm
SD 510mm
BH 380mm

Heavy Duty Visitor or
Meeting Chair, Black Sled
Base and Padded Arms

P100

\$59

COLOURS
Black



SW 450mm
SD 370mm
BH 405mm

Polypropylene Plastic
Stacking Chair
Available in Black or Grey



EXECUTIVE CHAIRS

\$715

160KG WEIGHT RATING

FABRICS
Black

AFRDI
LEVEL 6

NEW



WARRANTY 10 YEARS

ENDURE 160

SW	530mm	High Back, Heavy Duty Task Chair
SD	510mm	Italian Synchro Mechanism,
GH	460-560mm	Suitable for User up to 160kg - "142" Certification

\$249

FABRICS
Black PU

CL410



WARRANTY 5 YEARS

SW	540mm	Soft Black PU with Fabric Inlay, Infinite Tilt Lock, Chrome Base
SD	500mm	
GH	450-550mm	

\$261

FABRICS
Black PU

CL710



WARRANTY 5 YEARS

SW	530mm	Soft Black PU Upholstery, 4 Point Tilt Lock, High Back Chair
SD	530mm	
GH	460-550mm	

\$209

FABRICS
Black PU

CL610



WARRANTY 5 YEARS

SW	494mm	Soft Black PU Upholstery, Single Point Tilt Lock, Medium Back Chair
SD	500mm	
GH	450-580mm	

\$328

FABRICS
Black PU

CL820



WARRANTY 5 YEARS

SW	520mm	Soft Black PU Upholstery, Infinite Tilt Lock, Chrome Arms and Base
SD	480mm	
GH	420-490mm	

\$499

FABRICS
Black Leather

CL2000H



WARRANTY 10 YEARS

SW	510mm	High Back, Black Leather, Multi Position, Tilt Lock, Outward Adjust on Arms, Polished Aluminium Base
SD	500mm	
GH	500-565mm	

Chair Dimension Codes

SW = Seat Width
SD = Seat Depth
BH = Back Height
GH = Gas Height Range

EXECUTIVE CHAIRS

Chair Dimension Codes

SW = Seat Width

SD = Seat Depth

BH = Back Height

GH = Gas Height Range

CL2000M

\$485

FABRICS
Black Leather



WARRANTY 10 YEARS

SW 510mm Medium Back, Outward
SD 500mm Adjust on Arms, Slimline,
GH 500-565mm Multi Position Lock Tilt

CL2000V

\$399

FABRICS
Black Leather



WARRANTY 5 YEARS

SW 500mm Cantilever Visitor, Slimline
SD 500mm Chrome Frame, Outward
BH 630mm Adjust on Arms

LANDER

\$545

FABRICS
Black Leather



WARRANTY 10 YEARS

SW 510mm Fully Ergonomic, 3 Lever Heavy Duty Mechanism Executive
SD 510mm Chair with Black Leather and Adjustable Arms as Standard
GH 480-580mm Suitable for User up to 150kg and 24/7 Heavy Duty Use

PU900M

\$330

FABRICS
Black PU

WARRANTY 5 YEARS

NEW



SW 520mm Medium Back with Upholstered Black
SD 435mm PU Seat and Back, Single Point Lock,
GH 460-545mm Polished Aluminium Base

PU605M

\$293

FABRICS
Black PU



WARRANTY 5 YEARS

SW 485mm Medium Back, Infinite Lock
SD 460mm Tilt, Chrome Arms and
GH 490-610mm Base, Black PU

PU605H

\$335

FABRICS
Black PU



WARRANTY 5 YEARS

SW 485mm High Back, Infinite Lock
SD 460mm Tilt, Chrome Arms and
GH 490-610mm Base, Black PU

CONFERENCE & EVENTS CHAIRS

ZOOM

\$199



NEW

FABRICS

Black



ZOOM TABLET for use with Zoom Chair ONLY.

Tablet \$59



SW 460mm
SD 490mm
BH 330mm
Mesh Back with Back Rest Tilt, Foldable Training and Conference Chair, with Optional Extra Foldable Tablet Arm.

WIMBLEDON

\$89



COLOURS

Black



SW 425mm
SD 430mm
BH 245mm
Plastic Seat and Back, Chrome Sled Base Linking and Stackable



With Arms



Tablet Arm



Seat & Back Pad



Custom Upholstery (Lead Time applies)

COLOURS

Black



Trolley available for ZEST, PMVBK, ZOLA, ZING and WIMBLEDON Chairs ONLY.

ZOLA

\$55



COLOURS

Black

SW 460mm
SD 440mm
BH 200mm
Plastic Seat and Back Chrome Frame Stacking

ZEST

\$114



COLOURS

Black

SW 445mm
SD 450mm
BH 310mm
Conference or Meeting Chair, Chrome Sled Base, Linking and Stackable

ZING

\$89



COLOURS

Black



SW 465mm
SD 430mm
BH 370mm
Large Back and Seat Optional Extra: Arms Linking and Stackable

Chair Dimension Codes

SW = Seat Width

SD = Seat Depth

BH = Back Height

GH = Gas Height Range

\$135

COLOURS

Black

White

Red



SW 435mm
SD 455mm
BH 345mm
Indoor Hospitality Stool with Chrome Base, 750mm Seat Height, 1050mm Overall Height

LEO

\$89

COLOURS

Black

White

Red



SW 420mm
SD 410mm
BH 420mm
Suitable for Indoor or Outdoor Use, Aluminium Legs

Hospitality Chair Range

Compliment your café, lunch room or breakout areas with our comfortable and contemporary hospitality seating options.

TAURUS

\$114

COLOURS

Black

White

Red



SW 490mm
SD 510mm
BH 380mm
Indoor Hospitality Chair Chrome Base, Available in Red, Black or White

PIPEE

\$37

COLOURS

White

Grey

Green



SW 400mm
SD 380mm
BH 410mm
Polypropylene Plastic Stacking Chair, Holds up to 150kg, High Luster Shine



OTTOMANS

Ottoman Range

Soft Seating Ottomans provide communal, breakout and collaboration qualities to your office space. Choose from a variety of shapes, sizes & styles.

Ottoman Dimension Codes

SW = Seat Width

SD = Seat Depth

H = Height

\$145 **NEW** FABRICS
Charcoal

MARS ROUND



SW	550mm	Upholstered Round Ottoman,
SD	550mm	Ottoman,
H	450mm	Charcoal Fabric

\$145 **NEW** FABRICS
Charcoal

MARS SQUARE



SW	550mm	Upholstered Square Ottoman,
SD	550mm	Ottoman,
H	450mm	Charcoal Fabric

\$145 **NEW** FABRICS
Charcoal

MARS TRIANGLE



SW	550mm	Upholstered Triangle, Ottoman,
SD	550mm	Ottoman,
H	450mm	Charcoal Fabric

\$240 FABRICS
Black PU

VENUS OTTOMAN



SW	1030mm	Use as an Ottoman or Foot Stool, Black PU Finish and Stainless Steel Frame
SD	540mm	
H	410mm	

\$139 **NEW** FABRICS
Black PU

CONNECT 2 OTTOMAN



SW	320mm	Black Fabric Seat, White Powdercoated Steel Base, User up to 110kg
SD	320mm	
H	420mm	



CORNER LOZENGE



Converts Desk and Return to a Corner Workstation **From \$27**
 Will fit 25mm or 33mm D Tops
LOZENGE25 250W x 480L x 25D
LOZENGE33 250W x 480L x 33D

CHAIR MATS



Dimpled for use on Carpet, Smooth for Hard Floors **From \$62**
MAT S Small Dimpled 915W x 1200L x 20D
MAT L Large Dimpled 1140W x 1350L x 20D
MAT SM S Small Smooth 915W x 1200L x 20D
MAT SM L Large Smooth 1140W x 1350L x 20D

DOUBLE SIDED WHITEBOARD



Double Sided Pivoting Mobile Whiteboard, includes Pen Tray **From \$319**
M129 1200W x 900H x 15D
M159 1500W x 900H x 15D
M189 1800W x 900H x 15D

CORKBOARDS



Composite Corkboard
 Aluminium Frame
 Suitable for Pins or Stickers
C96 900W x 600H x 15D **\$65**
C129 1200W x 900H x 15D **\$105**

PINBOARDS



Includes 6 Pins

Grey Fabric Covered Commercial Pin Board,
 Brushed Aluminium Frame, Grey Fabric ONLY
 Wall Fix via Concealed Corner Fix
PIN96 600W x 600H x 15D **\$65**
PIN129 1200W x 900H x 15D **\$105**

WALL MOUNTED WHITEBOARD



- Wall Mounted
- Aluminium Framed
- Magnetic Whiteboard
- Pen Tray
- Concealed Corner Fixing
- Acrylic Polyester Resin Surface
- 4 Magnets Included

W96 900W x 600H x 15D **\$65**
W129 1200W x 900H x 15D **\$115**
W159 1500W x 900H x 15D **\$129**
W189 1800W x 900H x 15D **\$165**
W1812 1800W x 1200H x 15D **\$208**
W219 2100W x 900H x 15D **\$199**

DESK MOUNTED SCREENS

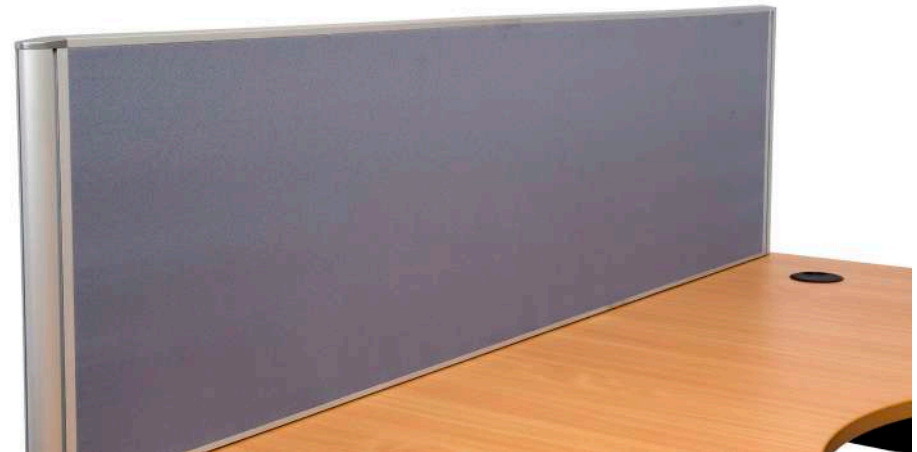

Flat Top, Clamp or Screw Fix to Workstation, Pinable Fabric
DMSF705 700W x 500H x 30D **\$188**
DMSF1205 1200W x 500H x 30D **\$209**
DMSF1505 1500W x 500H x 30D **\$231**
DMSF1805 1800W x 500H x 30D **\$252**

SCREEN COLOURS

Grey

Blue

ACOUSTIC SCREENS



Free Standing Dividing Office Panels, 50mm Thick, Pinable, Black PVC Edging and Silver Feet
1515SCREEN 1500W x 1500H x 50D **\$269**
1518SCREEN 1500W x 1800H x 50D **\$289**
1815SCREEN 1800W x 1500H x 50D **\$289**
1818SCREEN 1800W x 1800H x 50D **\$329**

SCREEN COLOURS

Grey

Blue



STEEL STORAGE



Personal Workstation Steel Storage Range

The Rapidline under desk storage range provides convenience, security and durability with ball-bearing drawer suspension, robust steel construction and anti-tilt mechanisms.

RAPIDLINE MOBILE PEDESTAL



- COLOURS
- Black Satin
 - White China
 - Precious Silver
 - Graphite Ripple

\$209

Rapidline Mobile Pedestal
Lockable, Full Extension Ball Bearing Runners,
Flush Drawer Front, Fifth Wheel for Stability
GMP3 3 Drawers 460W x 472D x 610H

COLOURS

White China

SLIMLINE MOBILE PEDESTAL



\$209

Slimline Mobile Pedestal
Ideal for Smaller Workstations to allow for
Extra Leg Room, Available in White ONLY.
GSP3 3 Drawers 300W x 472D x 610H

RAPIDLINE MOBILE CADDY



\$499

Rapidline Mobile Caddy - Available in White ONLY.
Flush Front Mobile Pedestal with Tambour Door Section with Centre Shelf, Fully Lockable
Ideal for Hot Desks or Workstation Return, Seat Cushion Available (Lead Time applies)
GCAD L Tambour Door Left Hand 1050W x 460D x 570H
GCAD R Tambour Door Right Hand 1050W x 460D x 570H

COLOURS

White China



Shelving Steel Storage Range

Declutter your office space and archive like a professional.

RAPIDLINE SHELVING UNIT

GSC9422 2200H X 910W X 400D

- Flat packed, easy assembly
- Includes 5 shelves
- Available in Silver Grey only

\$309

RAPIDLINE BOLTLESS

GV189 1830H X 914W X 457D

\$257

GV1812 1830H X 1220W X 457D

\$293

- Heavy duty, includes shelves as shown
- Available in Silver Grey only



COLOURS

Silver Grey

RAPIDLINE MOBILE SHELVING

- Space Efficient Method of Bulk Storage
- Easy to Level and Relocate Base
- 110kg Shelf Capacity
- White Powdercoat Finish, Lockable

4 BAY 2670L X 980W X 2150H **\$2970**

2670L X 1280W X 2150H **\$3300**

6 BAY 3560L X 980W X 2150H **\$4372**

3560L X 1280W X 2150H **\$4900**

8 BAY 4450L X 980W X 2150H **\$5775**

4450L X 1280W X 2150H **\$6500**

- With 4 Adjustable Shelves
- White only



COLOURS

White



STEEL STORAGE

LOCKERS



SINGLE DOOR

GL305/1 305W x 455D x 1830H **\$188**
GL380/1 380W x 455D x 1830H **\$199**
 - 380W in Silver ONLY

- Riveted Construction for Extra Strength
- Fitted with Hat Shelf and Coat Rail
- Vented Doors



2 DOOR

GL305/2 305W x 455D x 1830H **\$198**
GL380/2 380W x 455D x 1830H **\$209**
 - 380W in Silver ONLY

- Riveted Construction for Extra Strength
- Fitted with Coat Hook to each Compartment
- Vented Doors



4 DOOR

GL305/4 305W x 455D x 1830H **\$209**
GL380/4 380W x 455D x 1830H **\$219**
 - 380W in Silver ONLY

- Riveted Construction for Extra Strength
- Full Length Stiffeners Fitted to each Door
- Vented Doors



STEP LOCKER

Allows 2 Hanging Spaces in 380W Locker **\$259**

- Available in Silver Grey ONLY.
- 380W x 455D x 1830H
- Vented Doors

COLOURS
 White China
 Silver Grey



STAND ONLY

SB2305
 Stand ONLY for Bank of 2 x 305W Lockers
SB3305
 Stand ONLY for Bank of 3 x 305W Lockers



30° SLOPING TOP
G12830 Single
G32830 Bank of 3

Available for 305W Lockers ONLY.



BENCH SEAT
BS1000
 1000mm Wide Bench Seat Silver Grey ONLY.



SEAT & STAND

S+S2305
 Seat and Stand for Bank of 2 x 305W Lockers Silver Grey ONLY.

S+S3305
 Seat and Stand for Bank of 3 x 305W Lockers Silver Grey ONLY.

GO TAMBOUR DOOR CUPBOARDS AND ACCESSORIES



PLAIN SHELF
GTD900 900W
GTD1200 1200W



SLOTTED SHELF & DIVIDERS
GG09SLOT 900W
GG12SLOT 1200W
GS7D 5 Dividers



PULL OUT SHELF
GG09PS 900W
GG12PS 1200W



CLIP ON DIVIDERS
GSD6 175H



ROLL OUT FILING FRAME
GG09FF 900W
GG12FF 1200W



PLANTER BOX
PB 900 900W X 470D X 230H
PB 1200 1200W X 470D X 230H



From \$576

- (1016H, 1200H or 1981H) x (900W or 1200W) x 473D
- Adjustable feet, easy glide track and magnetic slam rail

COLOURS

White China

Silver Grey

GO LATERAL FILING CABINETS



2 DRAWER

GLF2
 ▪ 705H X 900W X 473D

\$499



3 DRAWER

GLF3
 ▪ 1016H X 900W X 473D

\$629



4 DRAWER

GLF4
 ▪ 1321H X 900W X 473D

\$719



STEEL STORAGE

GO CUPBOARDS



GCA10
1015H X 910W X 450D
▪ Includes 2 Shelves

\$272

GCA18
1830H X 910W X 450D
▪ Includes 3 Shelves

\$324

GCA20
2000H X 910W X 450D
▪ Includes 4 Shelves

\$398

GCWSG
Shelf and Coat Rail
▪ Silver Grey only

\$49



- Flush Lock with 2 Keys
- Available assembled or flat pack
- Tested to British Standards
- Available in Silver Grey, Graphite Ripple or White

GO STEEL FILING CABINETS



- Heavy duty, available in 4 Colours
- Fully Riveted with Ball Bearing Runners
- 40+ KG per drawer
- Tested to AFRDI Level 6

GFCA2 705H X 460W X 620D
GFCA3 1016H X 460W X 620D
GFCA4 1321H X 460W X 620D

\$215

\$259

\$299



COLOURS

- Black Ripple
- White China
- Silver Grey
- Graphite Ripple



COLOURS

- White China
- Silver Grey
- Graphite Ripple

GO WARDROBE



GO WARDROBE
1830H X 910W X 450D
Hanging and Storage
Space - Silver Grey only

\$399

RAPIDLINE FILING CABINETS



- 30+ KG per drawer
- Ball Bearing Runners
- Commercial quality,
- Available assembled or flat pack
- Available in Silver Grey, White China and Graphite Ripple

RFCA2 675H X 464W X 620D
RFCA3 980H X 464W X 620D
RFCA4 1290H X 464W X 620D

\$199

\$239

\$289

